

材料

一、風鈴

友禅柄

8.5cm 正方形 1枚

〃 〆紐



1cm x 8cm 1枚

〃 短冊



2cm x 4cm 1枚

二、紋取リ豚

友禅柄

15cm 正方形 1枚

〃 目

〃

2cm x 2.5cm 2枚

〃 目

シール (1ヶ)

持ち手紐 7cm 14

三、堂 2足

(金、墨) 奉書両面染

3cm 3.5cm = 等辺三角形 各1枚

〃 4cm 2枚

シール 各1枚

四、草

板締 x 和紙

9cm = 等辺三角形 1枚

五、下色紙

斜扇面

外島のり 内楕紙グレー色

一、風鈴

二階堂製子作

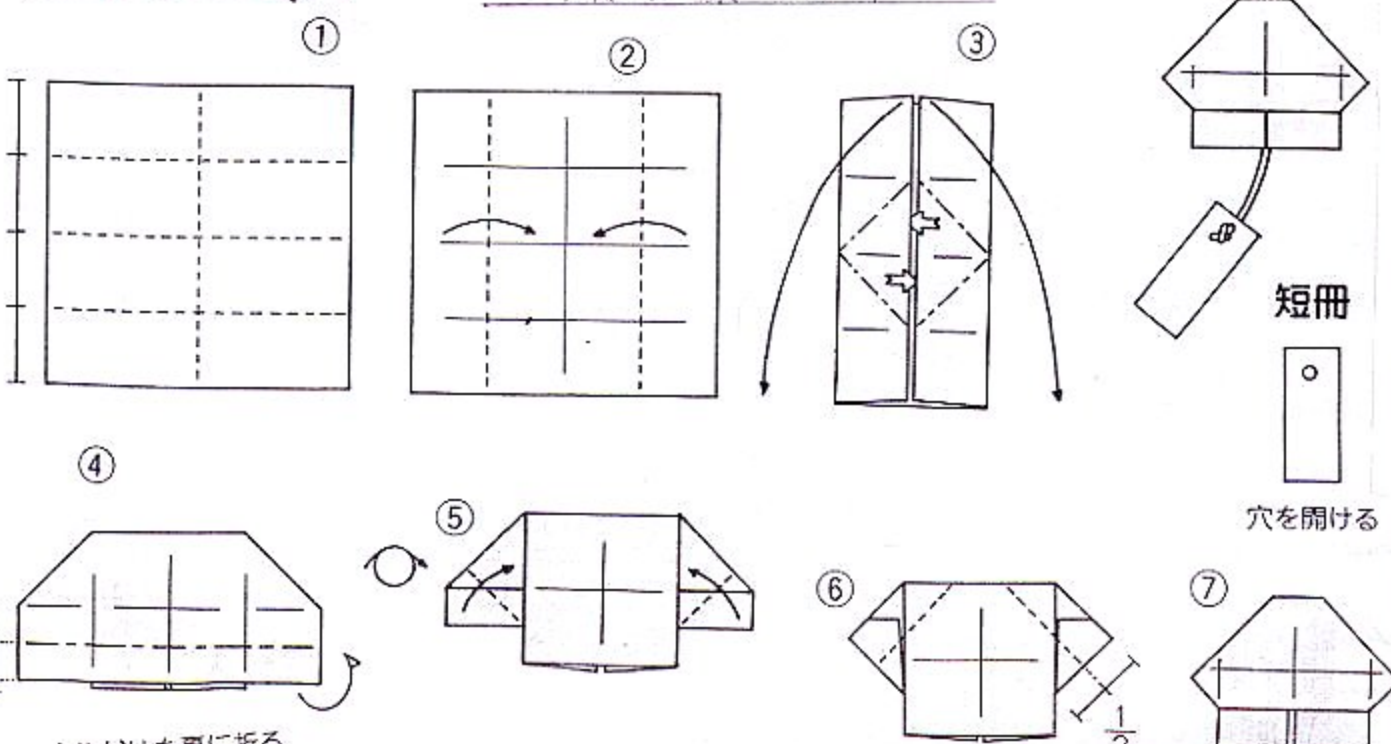

1枚だけを裏に折る

穴を開ける

二. 虫取り 豚

18%_m 正方形 (1枚)

No. 1

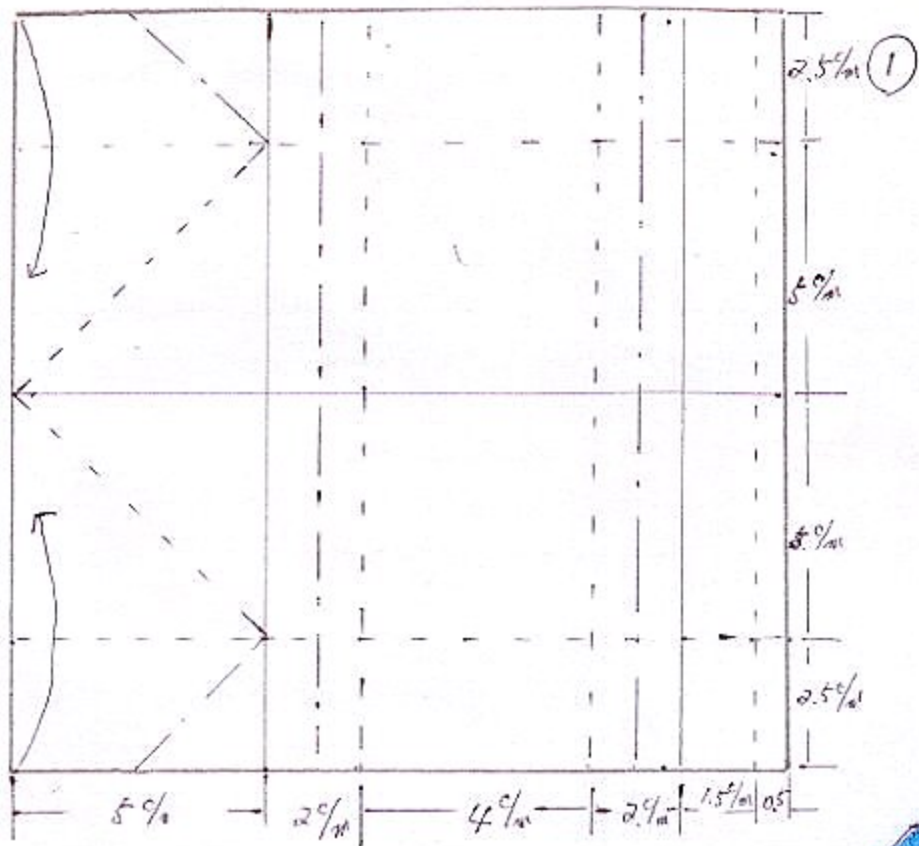

(2)

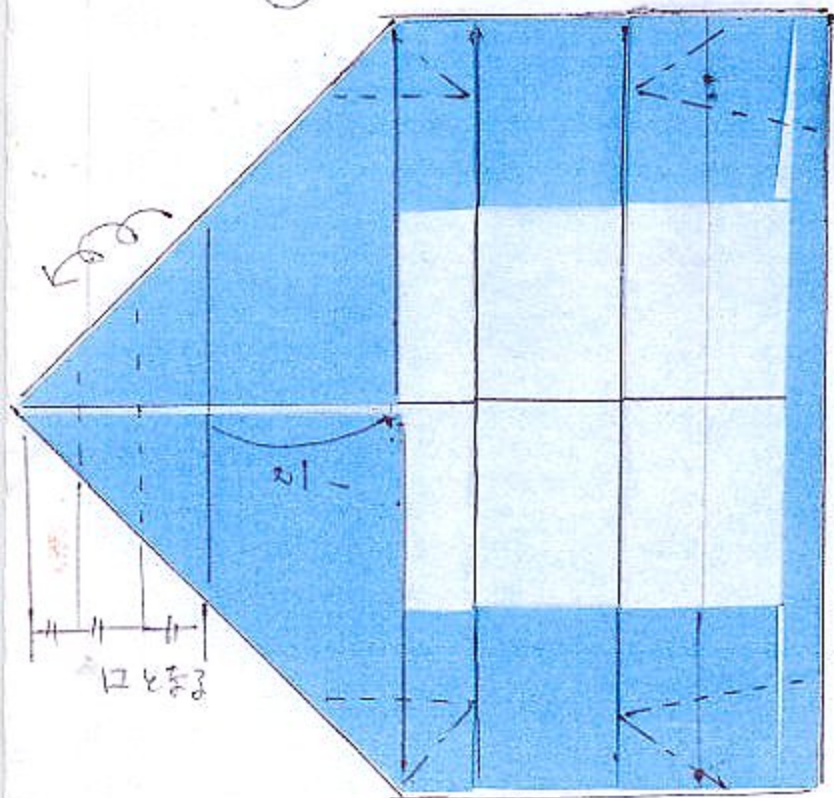

(3)

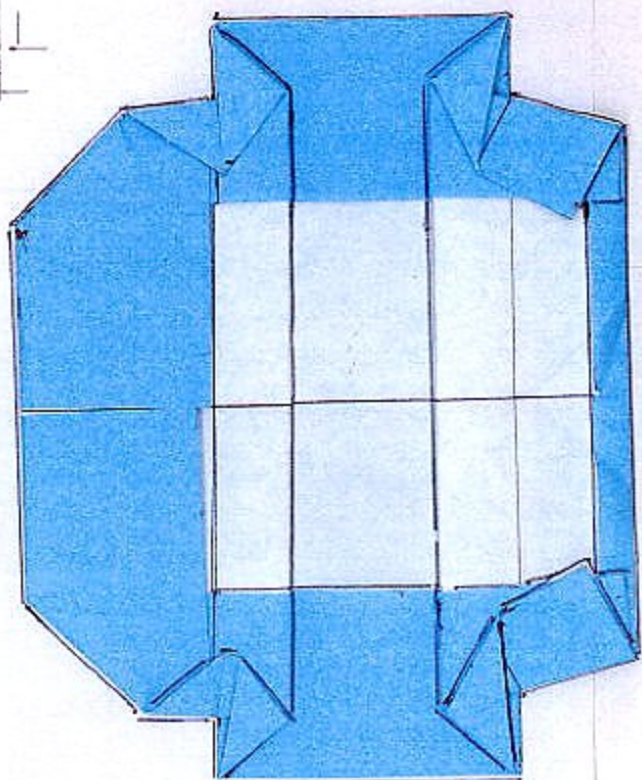

M 16. 6. 5. (±)

二. 蚊取り 豚

④

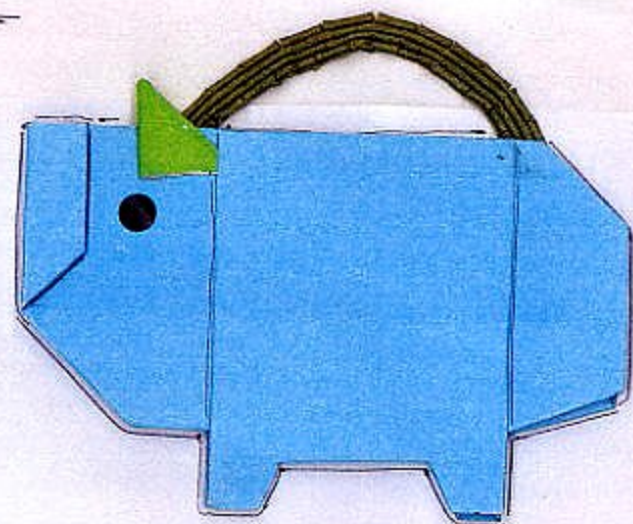
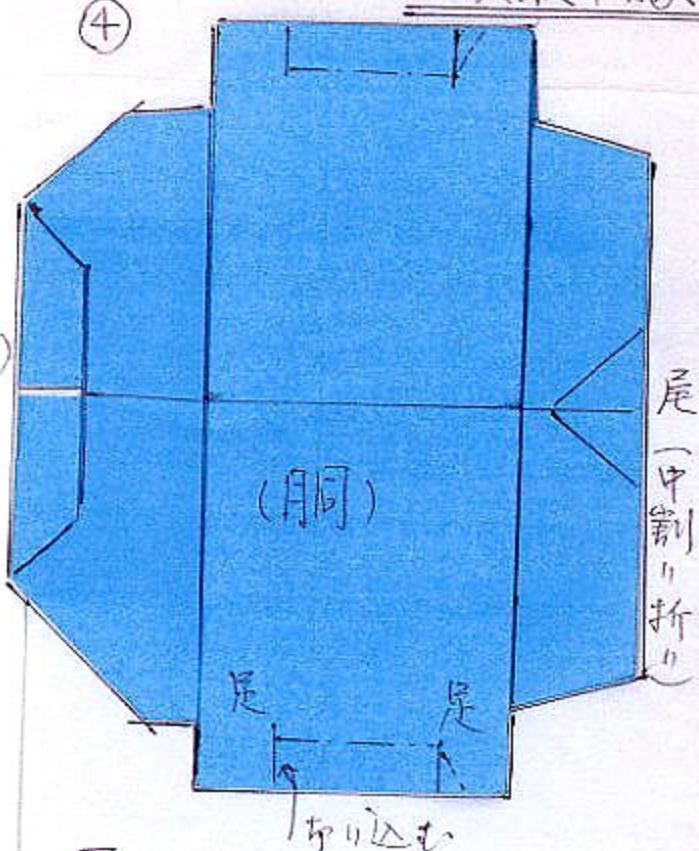

(*) 胴体はスポンジを入れる



*紙を折る = 折り込む

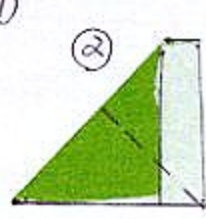
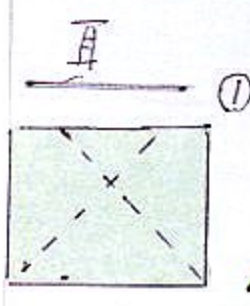

三. 虫 又 草

$3\%m$ $3.5\%m$ = 等辺三角形 各々 1枚づつ

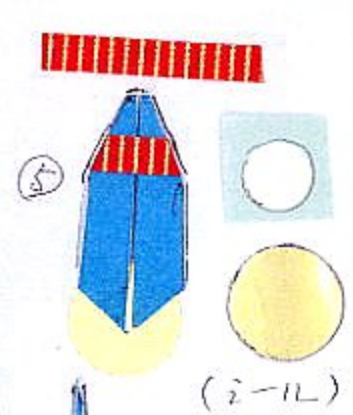
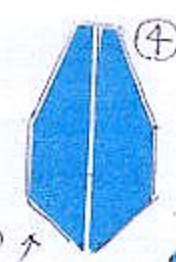
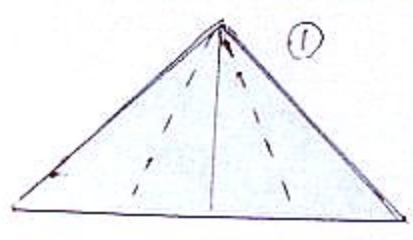

四 草

